

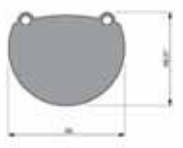









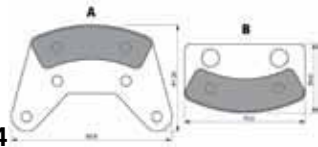
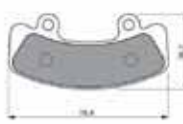







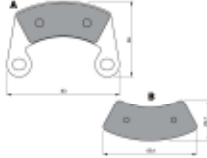

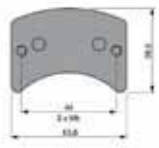
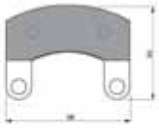
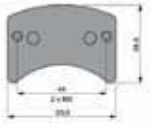

EXPORT PRICE LIST 2013 – AIRCRAFT BRAKE PADS AND DISCS

Typ	Price from 10 pair Material AD in euro	Price from 50 pair Material AD in euro	Material S33 in euro
900 	1 pair	1 pair	
901 	1 pair	1 pair	
903 	1 pair	1 pair	
904 	1 pair	1 pair	
905 	1 pair	1 pair	
906 	1 pair	1 pair	
907 	1 pair	1 pair	
908 			

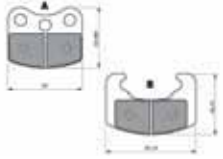
<p>909</p> 			
<p>910</p> 			
<p>912</p> 	<p>1 pair</p>	<p>1 pair</p>	
<p>913</p> 	<p>1 pair</p>	<p>1 pair</p>	
<p>914</p> 	<p>1 pair</p>	<p>1 pair</p>	
<p>915</p> 	<p>1 pair</p>	<p>1 pair</p>	
<p>916</p> 	<p>1 pair</p>	<p>1 pair</p>	
<p>918</p> 	<p>1 pair</p>	<p>1 pair</p>	
<p>918 R with rivets</p> 	<p>1 pair</p>	<p>1 pair</p>	
<p>919</p> 	<p>1 pair</p>	<p>1 pair</p>	
<p>919 R with rivets</p> 	<p>1 pair</p>	<p>1 pair</p>	

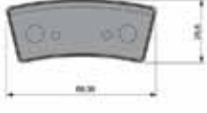
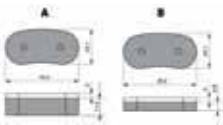
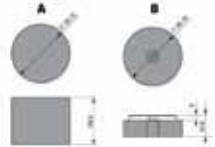
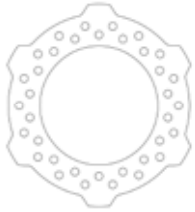
<p>924</p> 	<p>1 pair</p>	<p>1 pair</p>	
<p>925</p> 	<p>1 pair</p>	<p>1 pair</p>	
<p>926</p> 	<p>1 pair</p>	<p>1 pair</p>	
<p>927</p> 			
<p>928</p> 	<p>1 pair</p>	<p>1 pair</p>	
<p>929</p> 	<p>1 pair</p>	<p>1 pair</p>	
<p>930</p>	<p>1 pair</p>	<p>1 pair</p>	
<p>930 R with rivets</p> 	<p>1 pair</p>	<p>1 pair</p>	
<p>931</p> 	<p>1 pair</p>	<p>pair</p>	
<p>932</p> 	<p>1 pair</p>	<p>1 pair</p>	

 <p>400-522 in mat. 1/7</p>	<p>1 pc</p>
 <p>400-523</p>	
 <p>429-504</p>	<p>1 pc</p>

Terms of payment: T/T of the total amount after confirmation of order

